

Lowerable Pole Innovation

www.ezypole.com





EZYpole's Innovative Design

Ezypole's innovative range of lowerable poles has revolutionised the pole industry by reducing installation and on-going maintenance costs. We are now one of the leading pole suppliers to the private and public sectors around the world.

Our range of lowerable poles eliminate the use of any elevating working platforms and heavy lifting equipment such as cranes, which in turn eliminates O.H&S issues. Other benefits include easily accessing equipment at ground level in a matter of minutes through controlled lowering, this is done via a attachable manual winch system or simply walking the pole up or down with one or two men.

Whether you need to change a light fitting, clean a solar panel, upgrade radio transmitting equipment or just simply adjust a camera lens, the advantages of a lowerable pole will save you time and money in the long run.

APPLICATIONS

- ◆ Exterior Lighting
- ◆ Solar Lighting
- ◆ CCTV Security
- ◆ Time Lapse Cameras
- ◆ Weather & Monitoring Equipment
- ◆ Transmission & Radio Antennas
- ◆ Advertising & Signage
- ◆ Temporary Installations

KEY BENEFITS



Save Installation
Time



Installation at
ground level



Reduced
Installation &
Maintenance
Costs



OH&S
Compliant

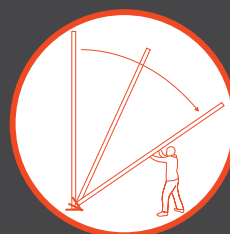

1 Person
Installation

EZYWinch Heavy Duty

The pole is lowered and raised with the aid of a 'demountable' manual winch frame that attaches to the lower section of the pole. The pole effortlessly and safely lowers to the ground and then can be easily 'winched' back up to its standing position.

APPLICATIONS



CCTV

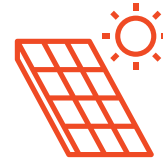

Solar



Lighting

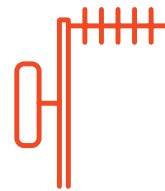

Transmission

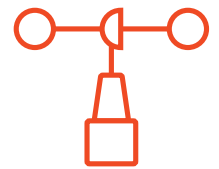

Instruments



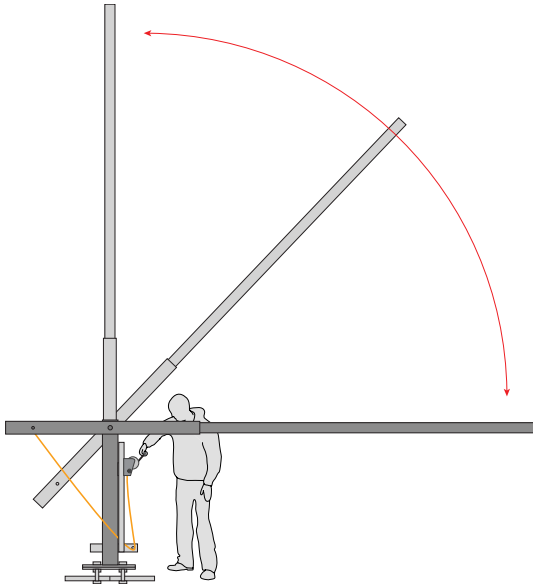

Pole Lowering Progression

KEY BENEFITS

- ◆ Suitable for all industrial and public access areas.
- ◆ Tilting of pole can usually be carried out by a single operator.
- ◆ Demountable winch assembly allows for a safe installation whilst also reducing costs on multiple installations.
- ◆ Constructed in high tensile steel and hot dip galvanised after fabrication for durability.
- ◆ Secure lockable access panel requires unique tool to access internal locking mechanisms.
- ◆ Internal locking and preventative fail mechanism for additional security.

Personnel Required for Installation	
Installation Time	30-60 minutes



EZYTilt Medium Duty

With its unique hinged base plate, the Medium Duty Pole winch pole allows the user a risk free method of lowering and raising the pole by attaching the winch frame to the base plate and the clipping a shackle to the winch attachment point of the pole.

APPLICATIONS



CCTV

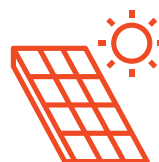

Solar



Lighting

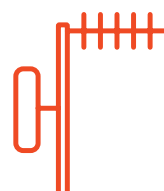

Transmission

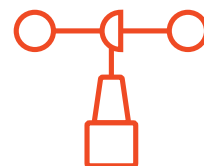

Instruments



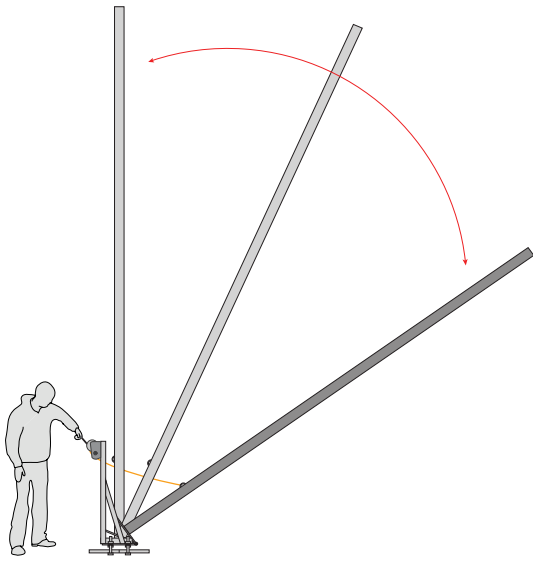

Pole Lowering Progression

KEY BENEFITS

- ◆ Suitable for all industrial and public access areas.
- ◆ Tilting of pole can usually be carried out by a single operator.
- ◆ Stable structure for all types of lighting, CCTV, Monitoring and solar applications.
- ◆ Demountable winch assembly allows for a safe installation whilst also reducing costs on multiple installations.
- ◆ Constructed in high tensile steel and hot dip galvanised after fabrication for durability.

Personnel Required for Installation	
Installation Time	30-60 minutes



EZYLift Light Duty

EZYLift is a lowerable pole that provides fast and safe installation for light duty applications. The pole utilises a cleverly designed lowerable base plate design with a removable hinge pin, it is easily raised by walking it up to a vertical position then fixing the 2 plates together with unique security bolts.

APPLICATIONS

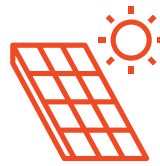

Solar



Lighting

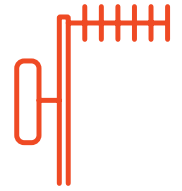

Transmission



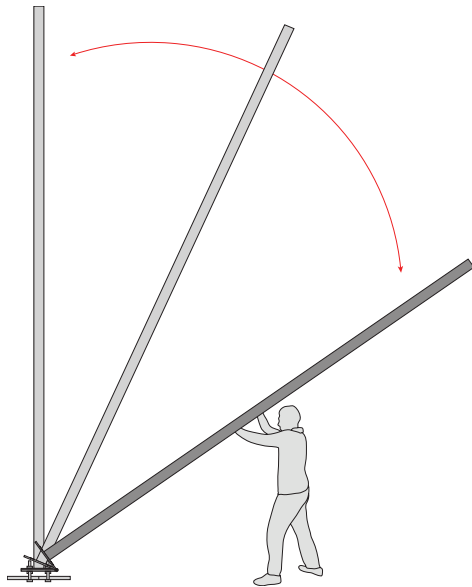

Pole Lowering Progression

KEY BENEFITS

- ◆ Suitable for all industrial and public access areas.
- ◆ Tilting of pole can usually be carried out by a single operator.
- ◆ Stable structure for light duty applications such as CCTV camera and LED light fittings.
- ◆ Hinged base plate design does not require any other equipment to assist lowering or raising the pole.
- ◆ Constructed in high tensile steel and hot dip galvanised after fabrication for durability.
- ◆ Optional Secure base cover prevents any unauthorised lowering of the pole.

Personnel Required
for Installation



Installation Time

15-30
minutes



Concrete-free Footing System

Our concrete-free footing provides a quick and environmentally friendly solution to support the entire EZYpole range of products. Typical concrete footing systems need a few days curing time before the poles can be installed, while EZY-footing allows full installation in under 60 minutes.

APPLICATIONS



CCTV

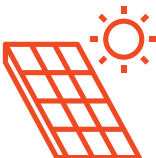

Solar



Lighting



Transmission

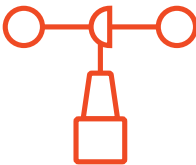

Instruments



KEY BENEFITS



Pole Lowering Progression

- ♦ Can handle bending moment loads of up to 700Kg's and
- ♦ load capacities that exceed 8.5 tonne.
- ♦ No concrete
- ♦ Reduce labour cost.
- ♦ No excavation or spoils.
- ♦ No engineering inspections required.
- ♦ Suitable in all wind categories and soil types.
- ♦ Great for hard to access, sloping or remote sites.

Personnel Required for Installation	
Installation Time	30-60 minutes





CONTACT US



2 Lanyon St, Dandenong South
Victoria, Australia 3175



+61 1300 EZYPOLE (1300 399 765)



info@ezypole.com